

FLUKE®

ii900

Sonic Industrial Imager

Users Manual

April 2019

©2019 Fluke Corporation. All rights reserved.

All product names are trademarks of their respective companies.

LIMITED WARRANTY AND LIMITATION OF LIABILITY

This Fluke product will be free from defects in material and workmanship for two years from the date of purchase. This warranty does not cover fuses, disposable batteries, or damage from accident, neglect, misuse, alteration, contamination, or abnormal conditions of operation or handling. Resellers are not authorized to extend any other warranty on Fluke's behalf. To obtain service during the warranty period, contact your nearest Fluke authorized service center to obtain return authorization information, then send the product to that Service Center with a description of the problem.

THIS WARRANTY IS YOUR ONLY REMEDY. NO OTHER WARRANTIES, SUCH AS FITNESS FOR A PARTICULAR PURPOSE, ARE EXPRESSED OR IMPLIED. FLUKE IS NOT LIABLE FOR ANY SPECIAL, INDIRECT, INCIDENTAL OR CONSEQUENTIAL DAMAGES OR LOSSES, ARISING FROM ANY CAUSE OR THEORY. Since some states or countries do not allow the exclusion or limitation of an implied warranty or of incidental or consequential damages, this limitation of liability may not apply to you.

Fluke Corporation	Fluke Europe B.V.	ООО «Флюк СИАЙЭС»
P.O. Box 9090	P.O. Box 1186	125167, г. Москва, Ленинградский
Everett, WA 98206-9090	5602 BD Eindhoven	проспект дом 37,
U.S.A.	The Netherlands	корпус 9, подъезд 4, 1 этаж

11/99

THIS PRODUCT IS LICENSED UNDER THE AVC PATENT PORTFOLIO LICENSE FOR THE PERSONAL USE OF A CONSUMER OR OTHER USES IN WHICH IT DOES NOT RECEIVE REMUNERATION TO (i) ENCODE VIDEO IN COMPLIANCE WITH THE AVC STANDARD ("AVC VIDEO") AND/OR (ii) DECODE AVC VIDEO THAT WAS ENCODED BY A CONSUMER ENGAGED IN A PERSONAL ACTIVITY AND/OR WAS OBTAINED FROM A VIDEO PROVIDER LICENSED TO PROVIDE AVC VIDEO. NO LICENSE IS GRANTED OR SHALL BE IMPLIED FOR ANY OTHER USE. ADDITIONAL INFORMATION MAY BE OBTAINED FROM MPEG LA, L.L.C. SEE [HTTP://WWW.MPEGLA.COM](http://www.mpegla.com).

Table of Contents

Title	Page
Introduction	1
How to Contact Fluke	1
Safety Information	1
Before You Start	2
Terms to Know	3
Battery	4
Features/Buttons	6
Hand Strap/Neck Strap	7
Display	7
Menus	8
Capture Mode (Image/Video)	8
Memory	8
Text Note	9
Photo Note	9
Acoustics	10
Show dB Scale: On or Off	10
Min dB / Max dB	10
Decibel Scaling	10
Frequency Profiles	10
Palette	10
Markers	10

Settings	11
File format	11
Date & Time	11
Display	11
Localization	11
Factory settings	11
Info	11
Basic Operation	12
File Transfer	13
Firmware Update	14
Maintenance	14
How to Clean the Case	14
Acoustic Sensor Care	14
Environmental	15
Service	15
Specifications	15

Introduction

The Fluke ii900 is a Sonic Industrial Imager (the Product or Imager) primarily used to detect and locate leaks in compressed air, compressed gas, and vacuum systems. The Imager has a visible light camera that captures a live-view image of the inspection area. An acoustic sensor-array aligns a sound-source heatmap with the image. Capture and save still image files and video files from the inspection for documentation and reports.

A rechargeable battery powers the Imager. The Imager includes an external battery charger with power adapter and country-specific cables.

The Imager has a USB-C port that connects to a PC for file download and firmware updates.

How to Contact Fluke

To contact Fluke, call one of the following telephone numbers:

- Technical Support USA: 1-800-44-FLUKE (1-800-443-5853)
- Calibration/Repair USA: 1-888-99-FLUKE (1-888-993-5853)
- Canada: 1-800-36-FLUKE (1-800-363-5853)
- Europe: +31 402-675-200
- Japan: +81-3-6714-3114
- Singapore: +65-6799-5566
- China: +86-400-921-0835
- Brazil: +55-11-3530-8901

Anywhere in the world: +1-425-446-5500

Or, visit Fluke's website at www.fluke.com.

To register your product, visit <http://register.fluke.com>.

To view, print, or download the latest manual supplement, visit <http://us.fluke.com/usen/support/manuals>.

Safety Information

For complete information about how to safely use this Product, read the *Safety Information* included with the Product or located on the Fluke website.

Before You Start

Table 1 is a list of items included with the Imager. Use the part numbers to order additional accessories.

Table 1. Standard Equipment

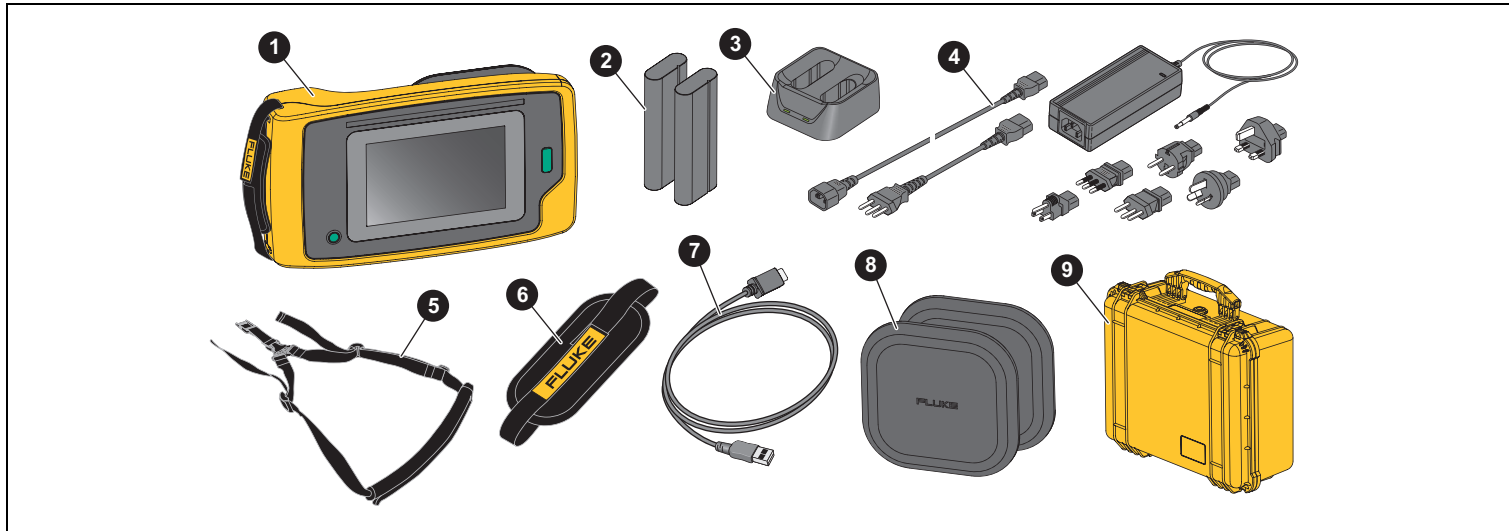

Item	Model Number	Description	Part Number
1	ii900	Imager	NA
2	BP291	Rechargeable Lithium-ion Battery Pack (x2)	3894688
3/4	EDBC290	External Battery Charger/Power Supply with Country-Specific Adapters	5077735
5	TiX5XX-NECK	Neck Strap	4574715
6	ii900 Hand Strap	Hand Strap	5075994
7	NA	USB-C Cable, 1 m (3.3 ft)	NA
8	ii900 Array Covers	Acoustic Sensor Covers (includes 1 spare cover)	5075982
9	CXT1000	Protective/Carry Case	4628917

Terms to Know

Use this section to familiarize yourself with these terms that are unique to this Imager and sound pressure measurements.

Decibel (dB) Sound Pressure Level (SPL). The unit of measurement for sound pressure changes. Decibel indicates the intensity (loudness) of the sound and is expressed in terms of dB SPL.

Distance to target. The distance between the leak source and the Imager acoustic sensor is critical. The decibel level that the Imager can measure decreases with the square of this distance.

Sound Frequency / Acoustic Frequency / Frequency Band. The frequency indicates the pitch of sound. The frequency corresponds to the number of sound vibrations/second and is expressed as Hertz (Hz) or thousands of Hertz (kHz).

Frequency Range

Audible (up to 20 kHz). The range that human ear can perceive sounds.

Ultrasonic (above 20 kHz). Certain issues (leaks, electrical discharges, mechanical failures) generate sound signatures in ultrasonic ranges. The human ear cannot perceive the ultrasonic range that the Imager can detect.

Frequency Selection / Frequency Filtering / Selected Frequency Band. Select a frequency band for measurement and visualization of sound. When a frequency band is selected, any sound outside of that range is filtered and not shown or considered.

Background Noise. The noise that exists in the surroundings that the microphone sensors detect along with the sound sources of possible leaks. Generally, background noise is higher in lower frequencies. In noisy environments, select higher frequencies to help discriminate the leak sounds.

Frequency / Spectrum Graph. A graphic chart on the display shows the intensity of sound detected in all frequency ranges up to 52 kHz.

Frequency Spike. Spike in the frequency / spectrum graph that indicates a significant source of sound in this specific frequency. If this spike is within the frequency selection, the Imager visualizes the source on the display.

Field-of-View (FOV). What is detected by the Imager at a particular position and orientation in space.

Sound Reflections. Sound signals reflect, particularly on smooth and flat surfaces. In certain conditions, the Imager shows on the display a hot spot from the source of noise and one or more hot spots from reflections.

Battery

Warning

To prevent personal injury and for safe operation of the Product:

- Do not put battery cells and battery packs near heat or fire.
- Do not put in sunlight.
- Do not disassemble or crush battery cells and battery packs.
- Remove batteries to prevent battery leakage and damage to the Product if it is not used for an extended period.
- Connect the battery charger to the mains power outlet before the charger.
- Use only Fluke approved power adapters to charge the battery.
- Keep cells and battery packs clean and dry. Clean dirty connectors with a dry, clean cloth.

Caution

To prevent damage to the battery:

- Do not expose battery to heat sources or high-temperature environments such as an unattended vehicle in the sun.
- Do not store the battery on the charger for more than 24 hours as reduced battery life may result.
- Charge the battery for a two-hour minimum at six-month intervals for maximum battery life. Without use, the battery will self-discharge in approximately six months.
- Always operate in the specified temperature range.
- Do not incinerate the Product and/or battery.

A Li-ion battery powers the Imager. The Imager includes two batteries for a quick-change during operation.

The battery charges on the 2-bay charging base. The power supply powers the charging base. Country-specific adapters are included.

The battery is tested in accordance with and complies to:

- UN Manual of Tests and Criteria Part III Subsection 38.3 (ST/SG/AC.10/11/Rev.5) – also known as the UN T19.T8 tests
- EN55022 and EN55024
- FCC part 15B
- UL2054/cUL60950-1
- IEC62133
- ROHS

The battery has an indicator with four LEDs (25 %, 50 %, 75 %, and 100 % charge) and a test button. To check the battery charge, push . The LEDs light to show the battery charge level. If all four LEDs are on, the battery charge is at 100 % of capacity. See Figure 1.

To recharge the battery:

1. Connect the ac power supply to the ac wall outlet and connect the dc output to the charger base.
2. Put one or two batteries into bay of charger base.
3. Charge battery.
4. Remove battery and push  to check the status.

To install the battery:

1. Open the battery door. See Figure 1.
2. Insert the battery.
3. Close the battery door. Make sure the door is firmly closed.

Figure 1. Battery

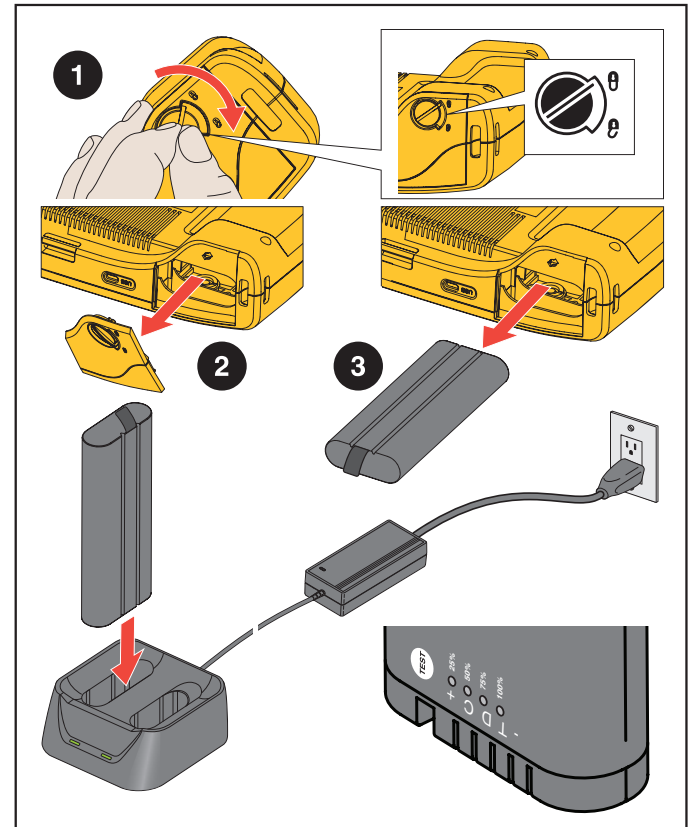

Features/Buttons

Table 2 is a list of the Imager features.

Table 2. Feature/Control Descriptions

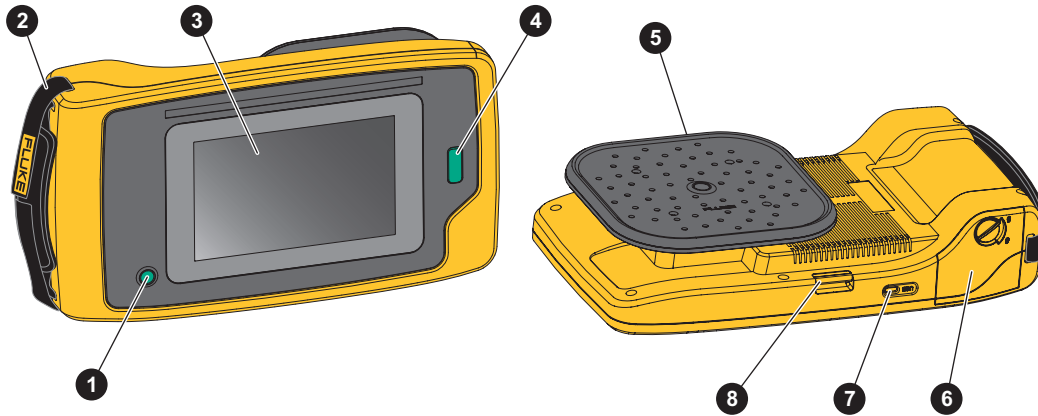

Button	Function	Button	Function
1	Power On/Off	5	Acoustic Sensor
2	Hand Strap	6	Battery Compartment
3	Touchscreen Display	7	USB-C Connector
4	Capture Button for Image or Start/Stop Video	8	Neck Strap Anchor

Hand Strap/Neck Strap

The Imager includes a hand strap and a neck strap that makes it easy to hold and operate as you take measurements. See Figure 2 for information about setup.

Figure 2. Hand Strap/Neck Strap



Display

The color display is a touchscreen that shows the test area as a visual image combined with a sound image. See Table 3.

With the touchscreen you are able to set up and adjust all the test parameters. For more information, see [Basic Operation](#).

Table 3. Touchscreen

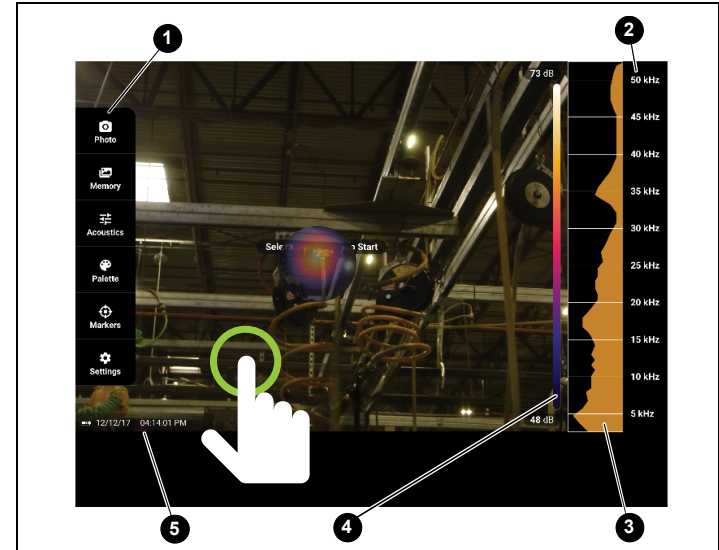

Item	Description
1	Tools Menu
2	Frequency Range of Spectrum
3	dB SPL of Spectrum (average of all microphones)
4	Palette of dB SPL Scale
5	Time/Date Stamp

Menus

To view the tool menu, tap your finger on the display. This action reveals the menu for parameter settings. Tap anywhere on the display outside the menu to hide the menu.

Capture Mode (Image/Video)

When you push the Capture button, you save an image as a still photo or a video of the scene.

To select the capture mode:

1. Open the tool menu.
2. Tap **Image/Video** to open the Capture Mode menu.
3. Tap either **Image** or **Video**.

The icon on the tool menu changes to show the selected mode.

4. Tap anywhere on the display outside the tool menu to hide the menu.

Memory

The Memory menu shows an overview of all the still photo and video captures with a thumbnail image. Each thumbnail includes an icon to indicate the file type:



To view an image or video, tap on the image once to open the file on the display.

To delete a single image file:

1. Tap on the image once to open the file on the display.
2. Tap  to delete the file.

To delete multiple image files:

1. Tap and hold an image file.
The mode changes to multi-file selection.
2. Tap all files to delete.
3. Tap  (see top right of the display) to delete multiple files.
4. Tap **Delete** to confirm the action.



An icon also identifies the annotation type.

 **Text Note**

To add a text note:

1. Tap on the image file to open the file on the display.
2. Tap  to edit a note.
3. Tap **X** or the Close Keyboard icon.

To Delete a text note:



1. Tap on the image file to open the file on the display.
2. Tap  to edit a note.
3. Tap  to delete the note.

 **Photo Note**

To add a Photo Note:

1. Tap on the image file to open the file on the display.
2. Tap  to open the Photo Note Menu.
3. Tap **+** to open the Camera view.
4. Push the **Capture** button to take the Photo.
The Imager adds the photo as a note.
5. Tap **X** to close the Photo Note menu.

To Delete a Photo Note:

1. Tap on the image file to open the file on the display.
2. Tap  to open the Photo Note Menu.
3. Tap on the Photo Note icon you want to delete.
4. Tap  to delete the Photo Note.

Acoustics

The Acoustics menu shows all the available settings for adjustment.

Show dB Scale: On or Off

You can choose to show or hide the dB scale. Turn off the dB scale to see a larger visual area on the display.

Min dB / Max dB

The minimum/maximum decibel settings determine the sound level (intensity) that shows on the SoundMap™. Decibel level thresholds help you to visualize leaks in challenging conditions, for example, very small leaks or a lot of background noise in the same frequency range as a leak. For more information, see [Frequency Profiles](#).

Auto On: Automatically adjusts the Color Palette Scale to the minimum/maximum decibel value for the received sound pressure.

Auto Off: The Color Palette Scale is a user-defined minimum/maximum decibel value. Levels above the maximum value show on the display with the same color as the maximum value. Levels below the minimum value do not show on the display.

Decibel Scaling

Use the slider to manually adjust the minimum and maximum in decibel values of the Color Palette Scale.

Frequency Profiles

A frequency profile is the band of frequencies that you select as an overlay on the visual image. The high and low frequency defines the band.

On: A preset profile is active. The icon in the center bottom of the display allows you to select a profile or save the current settings as a profile.

Off: Turn off the preset profile.

Palette

Select the palette for the acoustic image. The palettes offer an equal, linear presentation of colors for the best presentation of data detail.

Markers

When the Centerpoint Marker is On, the dB level of the Centerpoint shows on the display as value on the center of the display.

Note

The display shows the dB value of the selected frequencies as received in the center of the Field-of-View. This is not the dB value of the sound source.

Settings

The Settings menu shows all the available settings for adjustment.

File format

- set image format (JPEG or PNG)
- set video format (MP4 format)
- set the filename prefix

Date & Time

- set date and format
- set time and format

Display

- set the intensity of backlight
- set display timeout to save battery life
- set automatic power-off to save battery life
- display logo on or off

Localization

- select language
- set decimal separator to point or comma

Factory settings

- reset the unit to factory settings

Info

- firmware version
- certificates
- licenses

Basic Operation

The Imager works much like a point-and-shoot camera.

⚠ Caution

Do not place hand on or obstruct the acoustic sensor. Always use the sensor cover when the Product is not in use.

1. Remove the sensor cover before use.
2. Aim the Imager at the test area.
Ideal distance is 3 m to 7.6 m (10 ft to 25 ft). With good line-of-sight, >7.6 m to ≤21 m (>25 ft to ≤70 ft).
3. Select a band on the frequency spectrum on the right side of the display. See Table 4.
4. Change the width of the band by sliding the edges or move by sliding the middle of the band.
5. The optimum band depends on the environment and application. As an example for finding air or gas leaks, start with a band at 35 kHz and width that spans 5 kHz.

Table 4. Frequency Band Adjustment

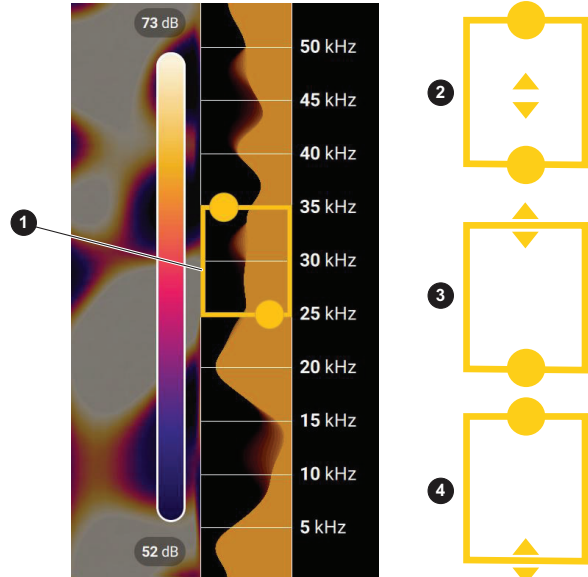

Item	Description
1	Frequency Band
2	Move within the Spectrum: Touch center of box until arrows show. Slide the box up and down to move the frequency range.
3	Adjust high end: Touch upper edge of box until arrows show. Slide edge up to change high end of the frequency range.
4	Adjust low end: Touch lower edge of box until arrows show. Slide edge down to change low end of the frequency range.

Note

High frequency peaks within the selected band may be caused by sources other than a leak. In this case, move the band to another frequency range.

If a strong source of sound is off the field-of-view, the display shows a circular pattern (flower) of hot spots on the SoundMap™. In this case, scan around for the source of sound.

6. When the area of interest clearly shows, push the **Capture** button. The Imager saves the image to memory.

Tip: Sound signals reflect, particularly on smooth and flat surfaces. In certain conditions, the Imager shows a steady spot on the source of noise and one or more steady spots from the reflections. Move the Imager around to help discriminate the sound source from the reflections. The sound source remains in the same location, while reflections will move.

For more information about how to view the images in memory, see [Memory](#).

File Transfer

To transfer saved files from the Imager to a PC:

1. Use the provided USB cable to connect the Imager to the PC. A USB drive is added to the list of drives on your PC.
2. Open the added USB drive to view the saved images or video files.
3. Copy the files you want to the local PC drive.
4. When transfer is complete, remove the USB drive from your PC.

Firmware Update

Firmware updates are available for the Imager. Go to www.fluke.com to find the most current firmware version.

To update:

1. Download the firmware update from the Fluke website to a PC.
2. Use the provided USB cable to connect the Imager to the PC with the new firmware file.
A popup message shows on the Imager display for permission to accept the USB access.
3. Tap **YES** to confirm.
A USB drive is added to the list of drives on your PC.
4. Copy the firmware update file from the PC to the root folder of the added USB drive. This is the memory of the product.
5. When the file copy is complete, safely remove the USB drive from your PC.
A popup message shows on the Imager display that informs a firmware update is found.
6. Tap **YES** to confirm and start the firmware update.
A popup message shows to request you to restart the Imager.

Maintenance

The Imager does not require routine maintenance.

⚠ Caution

The optical surfaces of the lens are equipped with high-quality optical layers. Avoid any contact with these surfaces and protect these surfaces against dirt and damages.

How to Clean the Case

Clean the case with a clean, damp cloth. Do not use abrasives, isopropyl alcohol, or solvents to clean the case or lens/window.

Acoustic Sensor Care

Always keep the Acoustic Sensor protected with the provided cover when the Imager is not in use. Avoid grease or liquids on the microphones. If the microphones are dirty or clogged, carefully clean with low air pressure from a compressed air duster at 25 cm to 30 cm (10 in to 12 in) distance. Avoid too much air pressure.

When you turn on the Imager, it does a self-check routine that detects faulty microphones. If you see a warning message to service the Acoustic Sensor when you turn on the Imager, clean the microphones with an air duster, restart the Imager, and check if the message continues. If yes, contact a Fluke Service Center. See [How to Contact Fluke](#) for more information.

Environmental

This Imager has electronic printed circuit boards. These components must be disposed of specifically when the device is at the end of its use.

The manufacturer offers to take back the Imager from the customer to ensure that the device is disposed of in an environmentally-friendly manner when it is at the end of its use.

See [How to Contact Fluke](#) for more information.

Service

An authorized Fluke Calibration service center should service the Imager at two-year intervals to maintain optimum performance.

Contact your equipment distributor or authorized Fluke Calibration Service Center for any equipment performance failure or to schedule regular maintenance service. See [How to Contact Fluke](#) for more information.

Specifications

For complete specifications, see the Fluke website.

